









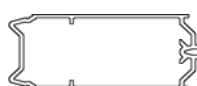

www.americanprod.com Email: bids@americanprod.com

Phone: 813-925-0144 Fax: 813-925-1414









Phone: 813-925-0144 Fax: 813-925-1414

FRAMING MEMBERS



DESCRIPTION	PART NUMBER	FOOT / UNIT	UNITS / PACKAGE	FINISH	LIST PRICE / UNIT
 <p>Light Mullion</p>	CW750-001	24'		Clear	\$389.92
				Bronze	\$409.02
				2-Coat Kynar	\$441.47
				Powder Coat	\$611.23
 <p>Heavy Mullion</p>	CW750-002	24'		Clear	\$424.22
				Bronze	\$443.33
				2-Coat Kynar	\$475.78
				Powder Coat	\$645.54
 <p>90 Degree Outside Corner</p>	CW750-005	24'		Clear	\$613.20
				Bronze	\$648.76
				2-Coat Kynar	\$701.48
				Powder Coat	\$843.02
 <p>1" Tongue Adaptor for 90 Degree Corner</p>	CW750-057	24'		Mill	\$350.73
 <p>90 Degree Outside Corner Interior Cover</p>	CW750-158	24'		Clear	\$237.94
				Bronze	\$262.47
				2-Coat Kynar	\$285.74
				Powder Coat	N/A
 <p>90 Degree Outside Corner Pressure Plate</p>	CW750-159	24'		Mill	\$244.05
 <p>90 Degree Outside Corner Cover</p>	CW750-160	24'		Clear	\$107.94
				Bronze	\$134.90
				2-Coat Kynar	\$153.30
				Powder Coat	\$210.08
 <p>90 Degree Inside Corner</p>	CW750-004	24'		Clear	\$643.86
				Bronze	\$679.42
				2-Coat Kynar	\$734.38
				Powder Coat	\$873.68
 <p>90 Degree Inside Corner Cover</p>	CW750-161	24'		Clear	\$181.52
				Bronze	\$201.15
				2-Coat Kynar	\$219.52
				Powder Coat	\$351.76
 <p>3/4" Cap</p>	CW750-003	24'		Clear	\$52.63
				Bronze	\$60.32
				2-Coat Kynar	\$73.92
				Powder Coat	\$117.20



FRAMING MEMBERS

DESCRIPTION	PART NUMBER	FOOT / UNIT	UNITS / PACKAGE	FINISH	LIST PRICE / UNIT
 Pressure Plate	CW750-050	24'		Mill	\$73.88
 Perimeter Pressure Plate	CW750-051	24'		Mill	\$105.48
 T-Anchor	CW750-152	Ea		Mill	\$8.96
 F-Anchor	CW750-153	Ea		Mill	\$8.44
 Shear Block	CW750-154	Ea		Mill	\$4.14
 Head and Sill Shear Block	CW750-155	Ea		Mill	\$3.38
 Perimeter F Anchor	CW750-156	24'		Mill	\$160.69
 Joint Plug	CW750-375	Ea		Rubber	\$.56

ADAPTORS

 1/4" Glass Adaptor	CW750-162			Clear	\$62.52
				Bronze	\$74.79
				2-Coat Kynar	\$87.05
				Powder Coat	\$96.57
 1/2" Glass Adaptor	CW750-163			Clear	\$71.12
				Bronze	\$85.85
				2-Coat Kynar	\$98.11
				Powder Coat	\$105.17

www.americanprod.com Email: bids@americanprod.com

Phone: 813-925-0144



Fax: 813-925-1414





www.americanprod.com Email: bids@americanprod.com

Phone: 813-925-0144 Fax: 813-925-1414

GASKET

DESCRIPTION	PART NUMBER	FOOT / UNIT	UNITS / PACKAGE	FINISH	LIST PRICE / UNIT
 Glazing Gasket for 1" Glass	CW750-376	250'		Black	\$238.56
 Perimeter Gasket	CW750-378	250'		Black	\$244.50
 Thermal Break	CW750-377	250'		Black	\$248.00

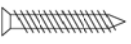
FASTENERS

 Shear Block to Mullion Screw	FA0004	Ea	100		\$42.00
 Horizontal to Shear Block Screw	FA0005	Ea	100		\$24.00
 Pressure Plate Screw	FA0006	Ea	100		\$48.00

ACCESSORIES

 1" Setting Block	CW750-379	Ea	1		\$1.43
--	-----------	----	---	--	--------

NOTES

API AMERICAN PRODUCTS, INC.	API AMERICAN PRODUCTS, INC.	API AMERICAN PRODUCTS, INC.	API AMERICAN PRODUCTS, INC.
API AMERICAN PRODUCTS, INC.	API AMERICAN PRODUCTS, INC.	API AMERICAN PRODUCTS, INC.	API AMERICAN PRODUCTS, INC.
API AMERICAN PRODUCTS, INC.	API AMERICAN PRODUCTS, INC.	API AMERICAN PRODUCTS, INC.	API AMERICAN PRODUCTS, INC.
API AMERICAN PRODUCTS, INC.	API AMERICAN PRODUCTS, INC.	API AMERICAN PRODUCTS, INC.	API AMERICAN PRODUCTS, INC.
API AMERICAN PRODUCTS, INC.	API AMERICAN PRODUCTS, INC.	API AMERICAN PRODUCTS, INC.	API AMERICAN PRODUCTS, INC.
API AMERICAN PRODUCTS, INC.	API AMERICAN PRODUCTS, INC.	API AMERICAN PRODUCTS, INC.	API AMERICAN PRODUCTS, INC.

SECTION F

www.americanprod.com Email: bids@americanprod.com

Phone: 813-925-0144 Fax: 813-925-1414

	PAGE
SUNSHADE/SUNSCREEN/LOUVER	
SUNSCREEN LOUVER SYSTEM	F1-1
SUNSHADE SYSTEM	F1-3
ARCHITECT LOUVER	F1-5
SUNSHADES	F1-7





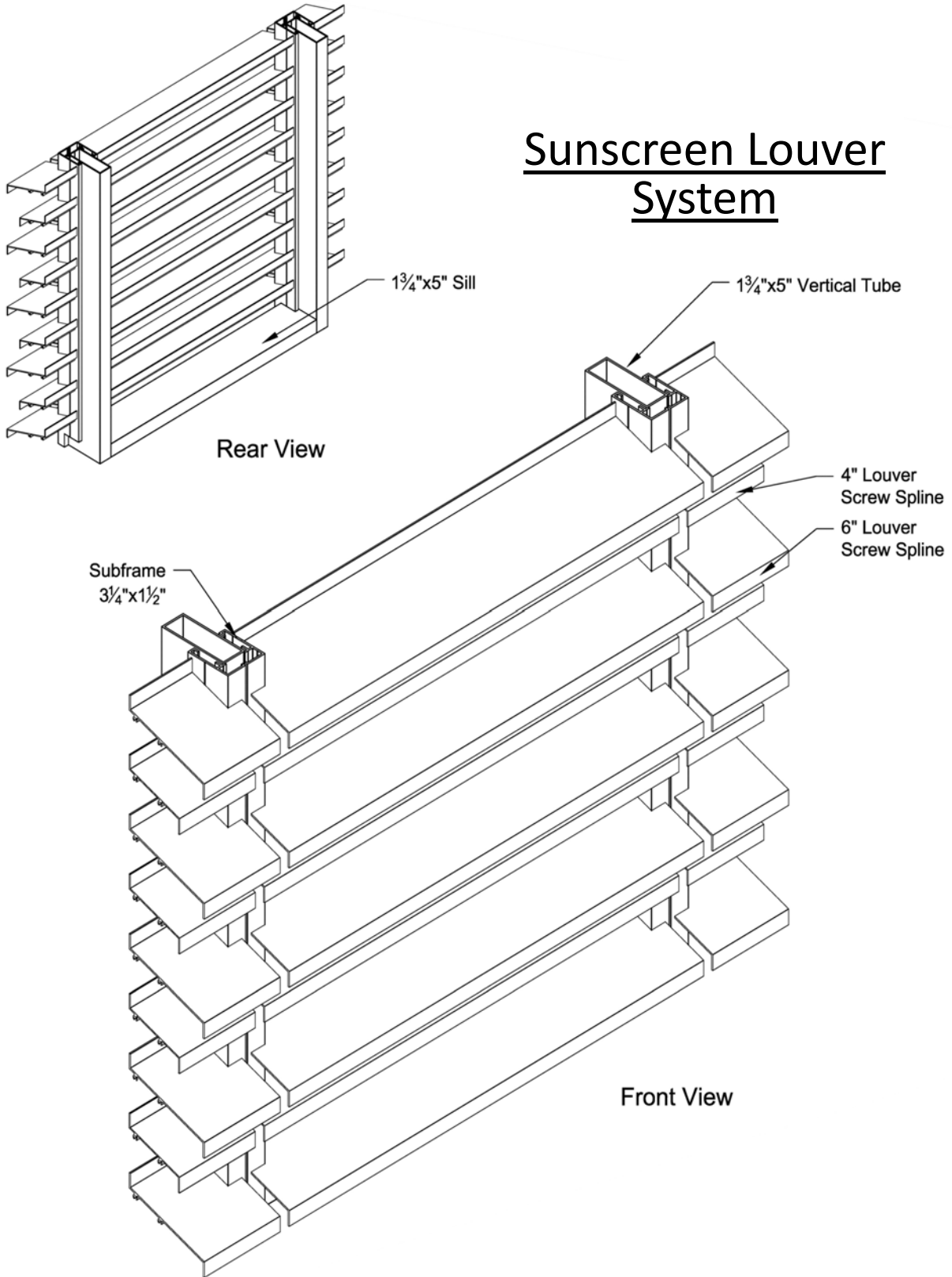

NOTES

API AMERICAN PRODUCTS, INC.	API AMERICAN PRODUCTS, INC.	API AMERICAN PRODUCTS, INC.	API AMERICAN PRODUCTS, INC.
API AMERICAN PRODUCTS, INC.	API AMERICAN PRODUCTS, INC.	API AMERICAN PRODUCTS, INC.	API AMERICAN PRODUCTS, INC.
API AMERICAN PRODUCTS, INC.	API AMERICAN PRODUCTS, INC.	API AMERICAN PRODUCTS, INC.	API AMERICAN PRODUCTS, INC.
API AMERICAN PRODUCTS, INC.	API AMERICAN PRODUCTS, INC.	API AMERICAN PRODUCTS, INC.	API AMERICAN PRODUCTS, INC.
API AMERICAN PRODUCTS, INC.	API AMERICAN PRODUCTS, INC.	API AMERICAN PRODUCTS, INC.	API AMERICAN PRODUCTS, INC.
API AMERICAN PRODUCTS, INC.	API AMERICAN PRODUCTS, INC.	API AMERICAN PRODUCTS, INC.	API AMERICAN PRODUCTS, INC.



LOUVER SYSTEMS

DESCRIPTION	PART NUMBER	FOOT/ UNIT	UNITS/ PACKAGE	FINISH	LIST PRICE/ UNIT
 <p>7" x 4" Louver Blade Screw Spline Attachment</p>	L00005	24'		Clear	Quote
				Bronze	Quote
				2-Coat Kynar	Quote
				Powder Coat	Quote
 <p>4-3/4" x 3-1/4" Screw Spline Attachment</p>	L00010	24'		Clear	Quote
				Bronze	Quote
				2-Coat Kynar	Quote
				Powder Coat	Quote
 <p>5" x 1-3/4" Louver Tube</p>	L00015	24'		Clear	Quote
				Bronze	Quote
				2-Coat Kynar	Quote
				Powder Coat	Quote
 <p>3-1/4 x 1-1/2 Louver Sub Frame</p>	L00020	24'		Clear	Quote
				Bronze	Quote
				2-Coat Kynar	Quote
				Powder Coat	Quote

www.americanprod.com Email: bids@americanprod.com

Phone: 813-925-0144

Fax: 813-925-1414



Sunshade System
8" Blade

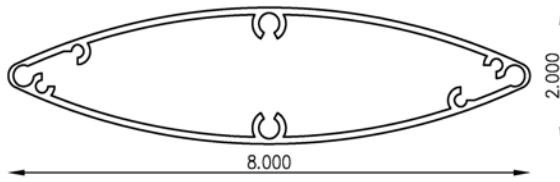
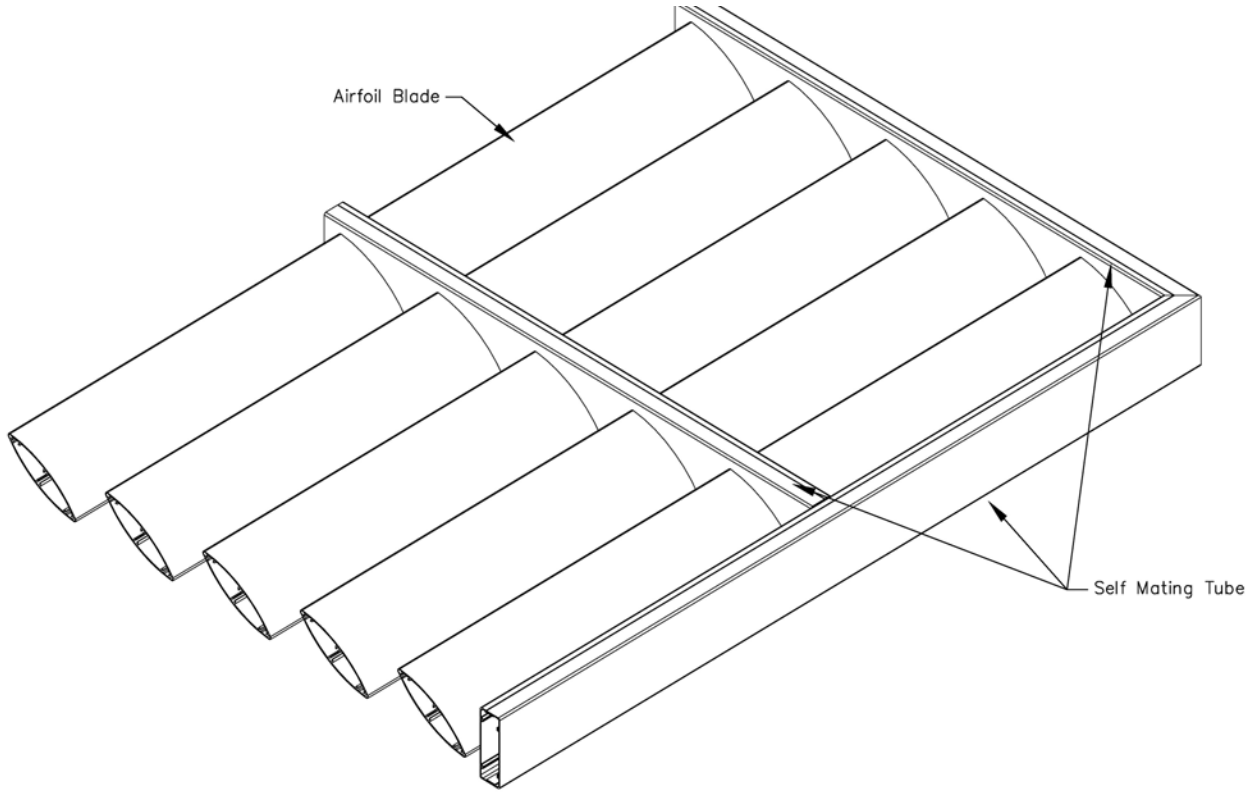

Airfoil Blade
Screw Spline

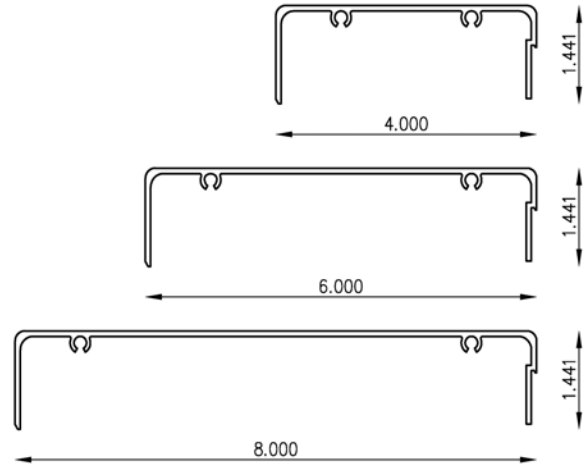

Self Mating Tube (Typ. 3)

www.americanprod.com Email: bids@americanprod.com

Phone: 813-925-0144 Fax: 813-925-1414

Phone: 813-925-0144 Fax: 813-925-1414



Sunshade System 6" Blade

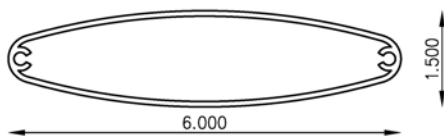
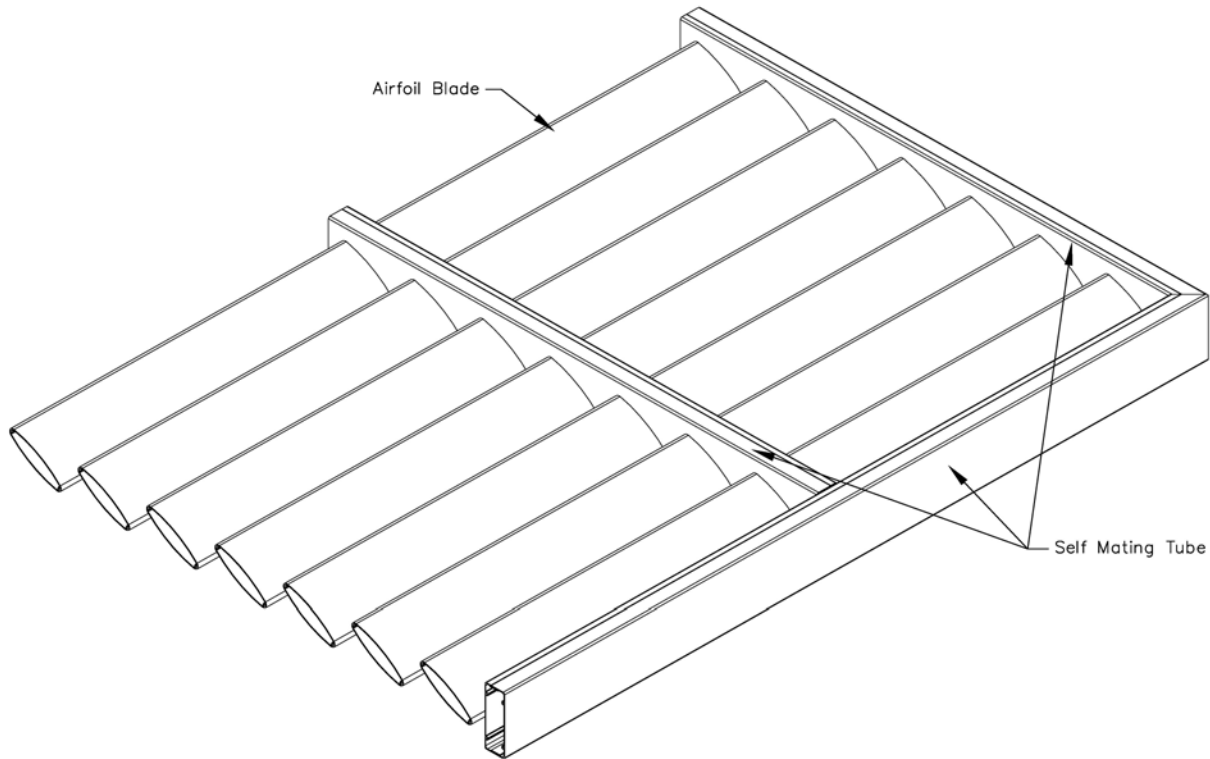

Airfoil Blade
Screw Spline

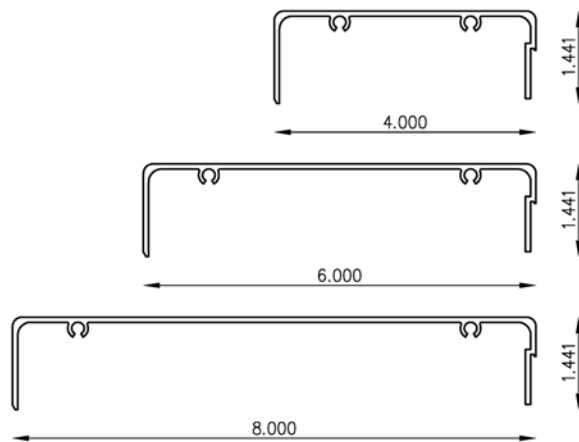

Self Mating Tube (Typ. 3)

www.americanprod.com Email: bids@americanprod.com

Phone: 813-925-0144 Fax: 813-925-1414



Architect Louver

www.americanprod.com Email: bids@americanprod.com

Fax: 813-925-1414

Phone: 813-925-0144

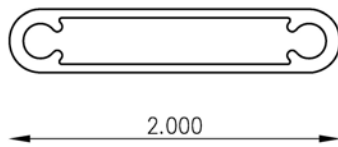
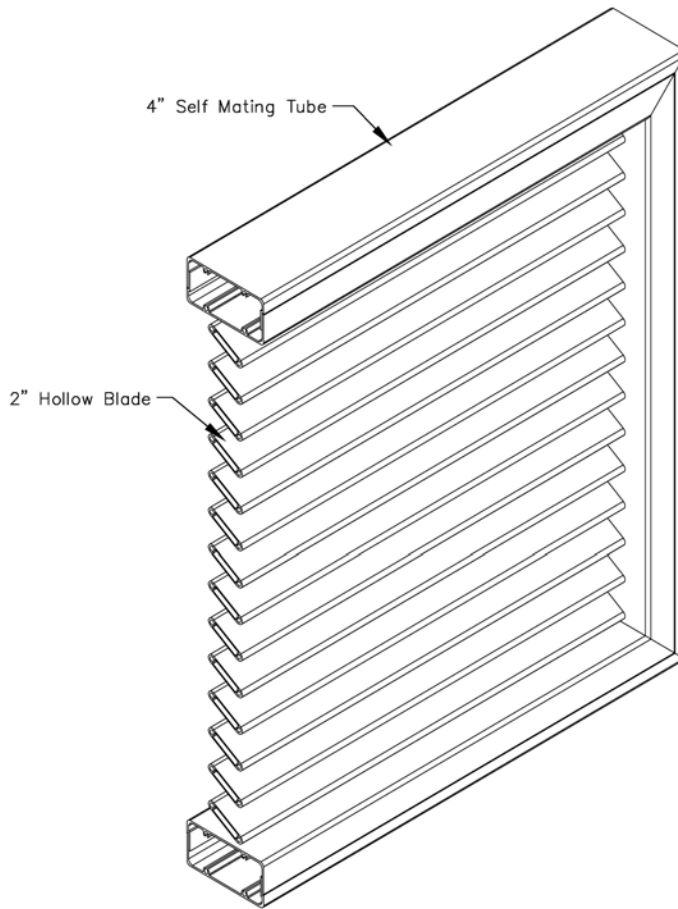

2" Hollow Blade
Screw Spline

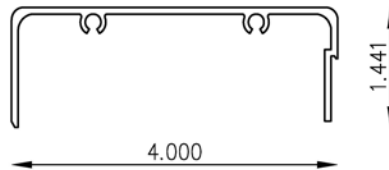

4" Self Mating Tube

Architect Louver 8" Blade

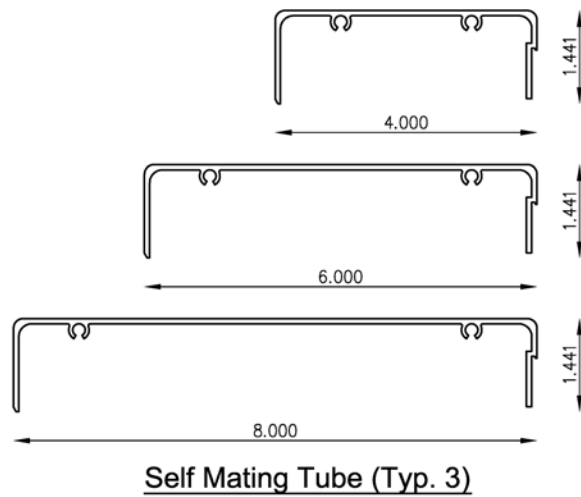
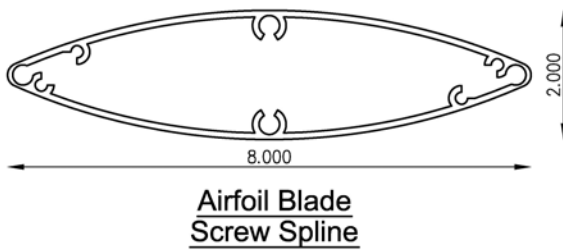
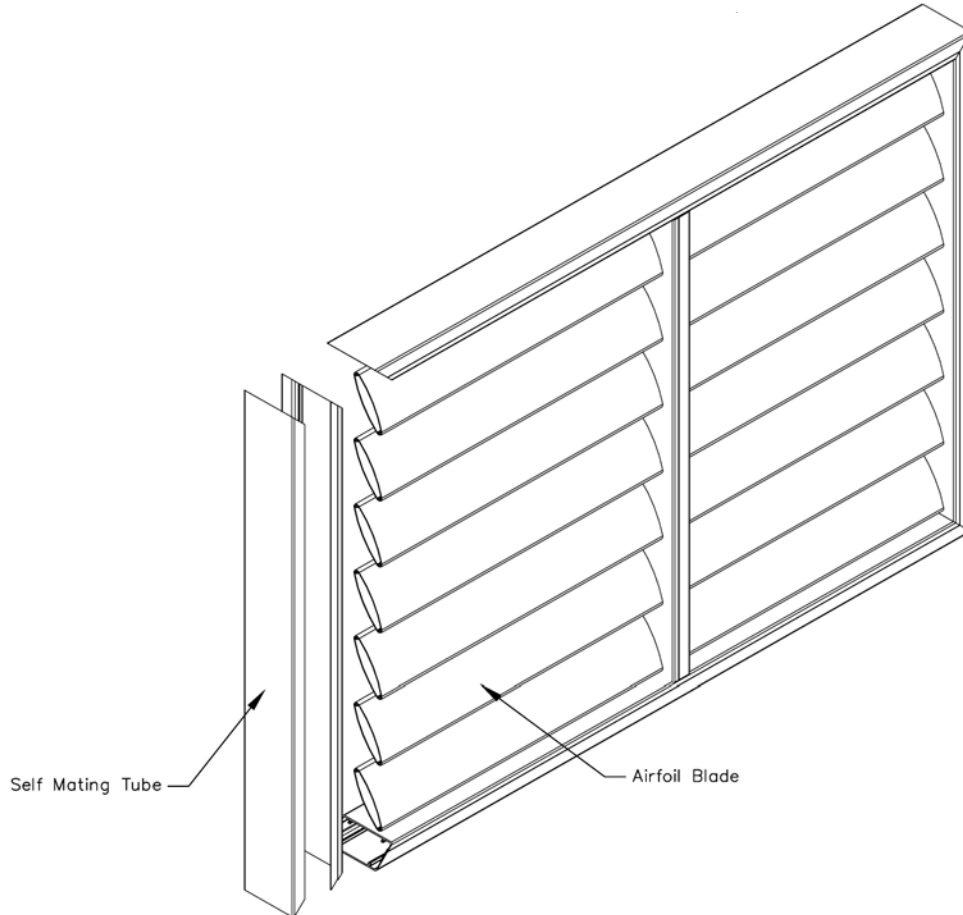











www.americanprod.com Email: bids@americanprod.com

Phone: 813-925-0144 Fax: 813-925-1414



SUNSHADE SYSTEMS





DESCRIPTION	PART NUMBER	FOOT/	UNITS/	FINISH	LIST PRICE/
 2-1/8" x 5/8" Air Foil Blade	S00005	24'		Clear	Quote
				Bronze	Quote
				2-Coat Kynar	Quote
				Powder Coat	Quote
 4" x 1" Air Foil Blade	S00010	24'		Clear	Quote
				Bronze	Quote
				2-Coat Kynar	Quote
				Powder Coat	Quote
 4" x 1" Air Foil Blade	S00020	24'		Clear	Quote
				Bronze	Quote
				2-Coat Kynar	Quote
				Powder Coat	Quote
 1-1/2" x 6" Air Foil Blade	S00025	24'		Clear	Quote
				Bronze	Quote
				2-Coat Kynar	Quote
				Powder Coat	Quote
 2" x 8" Air Foil Blade	S00030	24'		Clear	Quote
				Bronze	Quote
				2-Coat Kynar	Quote
				Powder Coat	Quote
 4" x 12" Air Foil Blade	S00035	24'		Clear	Quote
				Bronze	Quote
				2-Coat Kynar	Quote
				Powder Coat	Quote
 3" Round Bull Nose	S00040	24'		Clear	Quote
				Bronze	Quote
				2-Coat Kynar	Quote
				Powder Coat	Quote
 4" Half Round Bull Nose	S00045	24'		Clear	Quote
				Bronze	Quote
				2-Coat Kynar	Quote
				Powder Coat	Quote
 2" Hollow Blade	S00050	16'		Clear	Quote
				Bronze	Quote
				2-Coat Kynar	Quote
				Powder Coat	Quote
 2" Solid Blade	S00055	20'		Clear	Quote
				Bronze	Quote
				2-Coat Kynar	Quote
				Powder Coat	Quote
 3" x 1" Radius Tube	S00060	24'		Clear	Quote
				Bronze	Quote
				2-Coat Kynar	Quote
				Powder Coat	Quote

www.americanprod.com Email: bids@americanprod.com

Phone: 813-925-0144 Fax: 813-925-1414



SUNSHADE SYSTEMS

DESCRIPTION	PART NUMBER	FOOT/	UNITS/	FINISH	LIST PRICE/
 4" x 1" Radius Tube	S00065	24'		Clear	Quote
				Bronze	Quote
				2-Coat Kynar	Quote
				Powder Coat	Quote
 5" x 1" Radius Tube	S00070	24'		Clear	Quote
				Bronze	Quote
				2-Coat Kynar	Quote
				Powder Coat	Quote
 4" Self Mating Tube 2" x 4" When Mated	S00075	24'		Clear	Quote
				Bronze	Quote
				2-Coat Kynar	Quote
				Powder Coat	Quote
 6" Self Mating Tube 2" x 6" When Mated	S00080	24'		Clear	Quote
				Bronze	Quote
				2-Coat Kynar	Quote
				Powder Coat	Quote
 8" Self Mating Tube 2" x 8" When Mated	S00085	24'		Clear	Quote
				Bronze	Quote
				2-Coat Kynar	Quote
				Powder Coat	Quote

www.americanprod.com Email: bids@americanprod.com

Phone: 813-925-0144

Fax: 813-925-1414

